

# Solid State Relay

## 固態繼電器

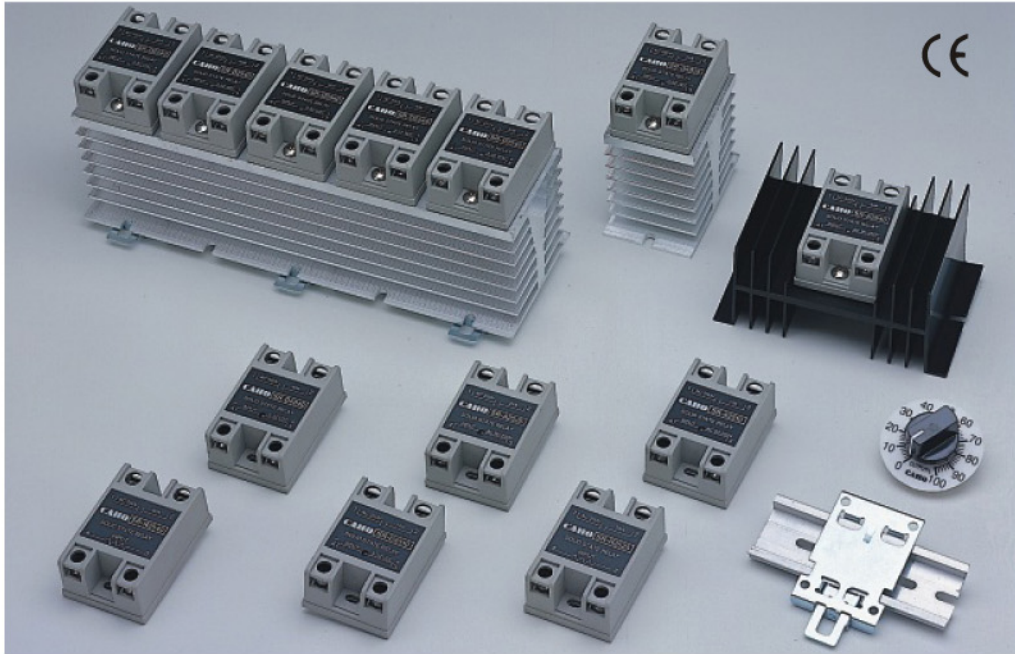

### Features:

1. Load current ranges from 10 to 40 Amps.
2. Internally mounted snubber circuit protection for huge current(dv/dt) application
3. Zero Crossing turn-on, Zero current turn-off.
4. With LED display to detect the operating of devices.
5. Photo-isolation, 4000V Rms isolation.
6. R SERIES have output power 0~90%
7. Ambient Temperature:-10~55°C
8. Weight:70g

### 特性:

1. 負載額定電流10A~40A。
2. 內部提供RC電路防止突波產生。
3. 零電位導通。
4. 使用LED顯示觸發狀態。
5. 採光耦合隔離4000V Rms。
6. R系列輸出範圍可調0~90%。
7. 適用環境溫度：-10~55°C。
8. 重量：70公克。

### SPECIFICATIONS 規格說明

(Ta=25°C)

Model No.	SR-D25 □□ SR-D48 □□	SR-A25 □□ SR-A48 □□	SR-R25 □□
Data	(DC-AC)	(AC-AC)	(VR-AC)
TYPE	(DC-AC)	(AC-AC)	(VR-AC)
Input Signal Voltage	3-32V DC	90~250V AC 90~480V AC	VR B200KΩ
Output Load Voltage Range	90~250V AC 90~480V AC	90~250V AC 90~480V AC	250V AC
Load Current	10A 25A 40A	10A 25A 40A	10A 25A 40A
Max. 1-Cycle Surge Current	125A 260A 315A	125A 260A 315A	125A 260A 315A
Max. On-State Voltage Drop	1.6V AC		
Response Time	1/2 cycle + 1 msec.	3/2 cycle + 1 msec.	
Dielectric Strength	10 <sup>8</sup> ohms	10 <sup>8</sup> ohms	
Isolation between Input/Output	2500V(RMS)	2500V(RMS)	
Isolation Input/Output to Case	2500V(RMS)	2500V(RMS)	
Capacitance	15 pf(Max.)	15 pf(Max.)	
Operating Temperature	-20°C~80°C	-20°C~80°C	
Storage Temperature	-40°C~80°C	-40°C~80°C	
Weight(approx.)	70g	70g	70g

**DIMENSION 尺寸圖**

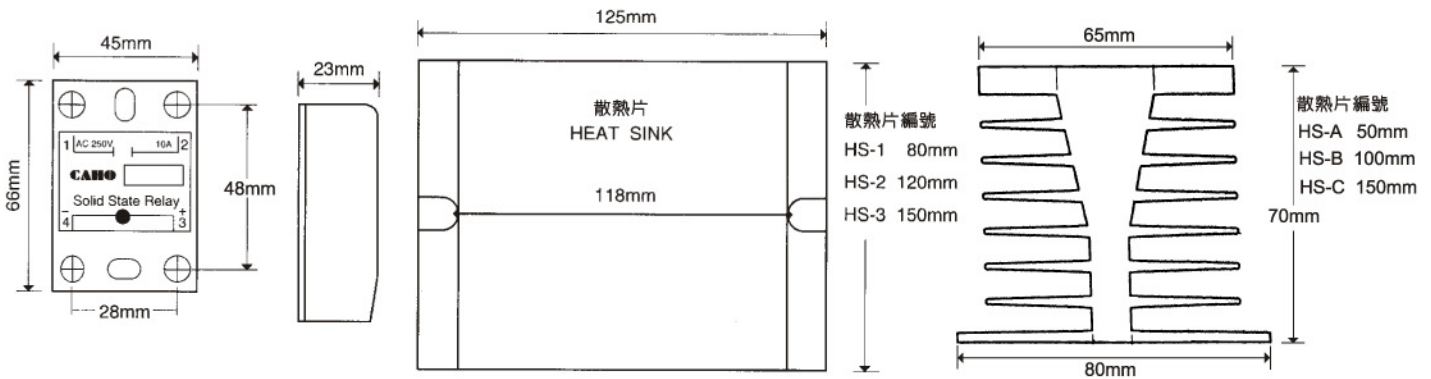

**CHARACTERISTIC CURVES**

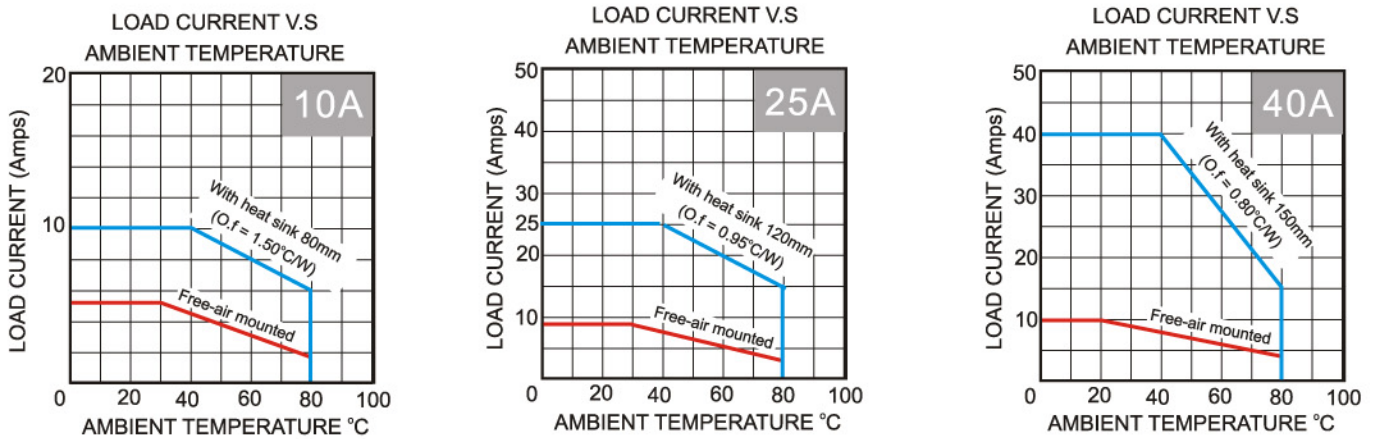

**ORDERING CODE 訂貨編號**

Model No. 型號		SR-	
Series 系列	DC-AC	D	
	AC-AC	A	
	VR-AC	R	
Line Voltage 負載電壓	250V AC	25	
	480V AC	48	
Load Current 負載電流	10A		10
	25A		25
	40A		40
Heat Sink 散熱片	None fitted		N
	Fitted with Heat Sink 125x60x80mm		1
	Fitted with Heat Sink 125x60x120mm		2
	Fitted with Heat Sink 125x60x150mm		3
	Fitted with Heat Sink 80x70x50mm		A
	Fitted with Heat Sink 80x70x100mm		B
	Fitted with Heat Sink 80x70x150mm		C
	Fitted with Heat Sink 80x70x250mm		D
	Fitted with Heat Sink 80x70x500mm		E
Fitted with Heat Sink 80x70x200mm		G	
DIN rail adapter option 鉤軌固定座選配	Just for HS-A,B or C ,D,E,G Heat Sink 只適合HS-A,B,C,D,E,G六種散熱片		S



※ 負載測試：負載未接或電流太小(1A以下)無法正常導通，測試時請接1A以上之負載。

# Solid State Relay (Large Current 40A~80A)

## 固態繼電器 (大安培 40A~80A)

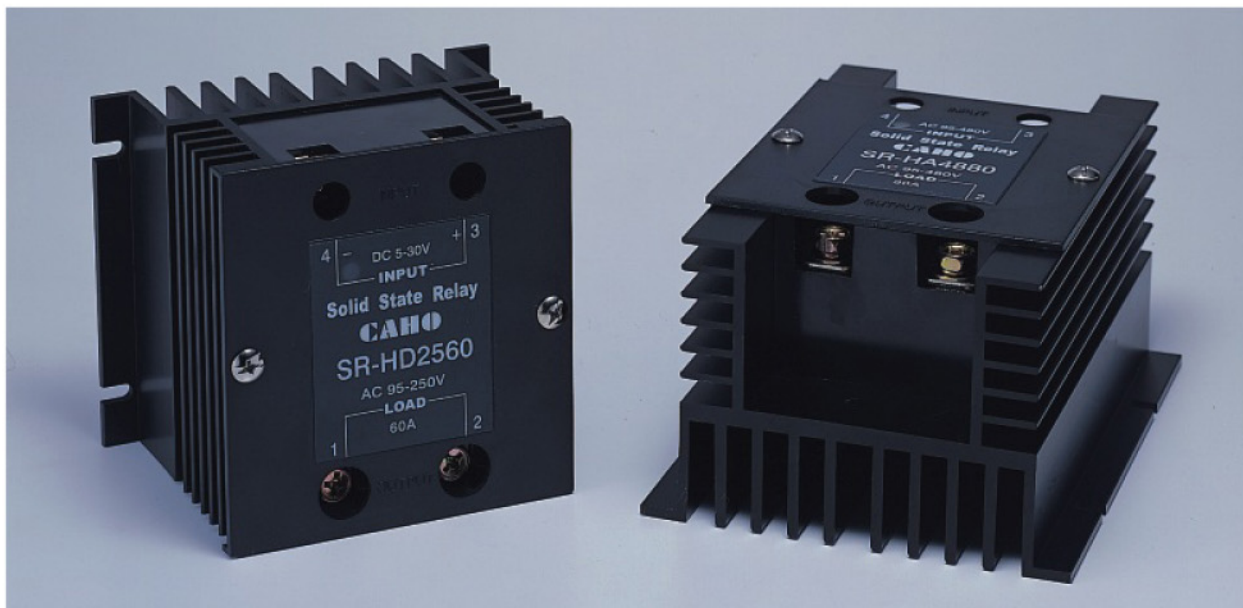

### ■ Features:

1. Load current ranges from 40 to 80 Amps.
2. Internally mounted snubber circuit protection for huge current(dv/dt) application.
3. Zero Crossing turn-on, Zero current turn-off.
4. With LED display to detect the operating of devices.
5. Photo-isolation, 4000V Rms isolation.
6. HR SERIES have output power 0~90%
7. Ambient Temperature:-10~55°C
8. Weight:1.3kg

### ■ 特性:

1. 負載額定電流40A~80A。
2. 內部提供RC電路防止突波產生。
3. 零電位導通。
4. 使用LED顯示觸發狀態。
5. 採光藕合隔離4000V Rms。
6. HR系列輸出範圍可調0~90%。
7. 適用環境溫度：-10~55°C。
8. 重量：1.3公斤。

### ■ SPECIFICATIONS 規格說明

Model Number 型號	Series 系列	Input Signal Voltage 輸入電壓	Output Load Voltage 輸出電壓	Load Current 電流
SR-HD25 □□	DC-AC	DC5-30V	AC 250V	40A
				60A
				80A
SR-HD48 □□	DC-AC	DC5-30V	AC 480V	40A
				60A
				80A
SR-HA25 □□	AC-AC	AC 220V	AC 250V	40A
				60A
				80A
SR-HA48 □□	AC-AC	AC 440V	AC 480V	40A
				60A
				80A
SR-HR25 □□	VR-AC	VR B200KΩ	AC 250V	40A
				60A
				80A

**DIMENSION 尺寸圖**

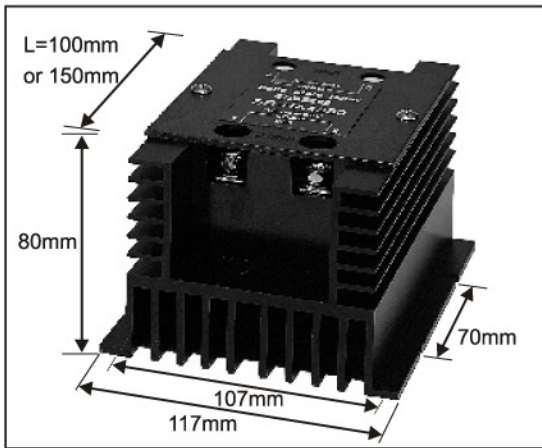

※ L=100mm for 40.60A  
L=150mm for 80A

**ORDERING CODE 訂貨編號**

		Model No. 型號		
		SR-		
Series 系列	DC-AC	HD		
	AC-AC	HA		
	VR-AC	HR		
Line Voltage 負載電壓	AC 250V		25	
	AC 480V		48	
Load Current 負載電流			40A	40
			60A	60
			80A	80

**S.S.R (模組式) SINGLE PHASE WIRING EXAMPLE 接線範例**

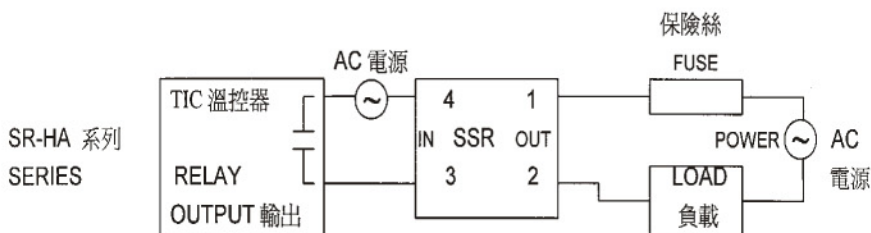
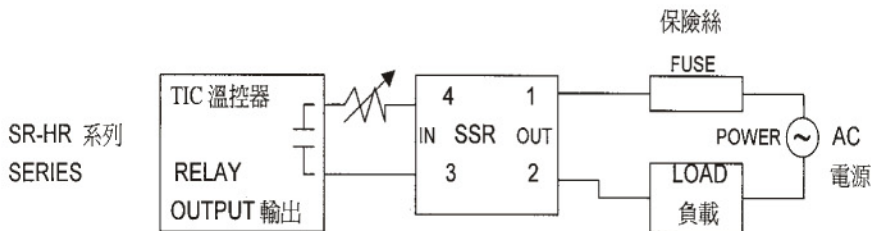
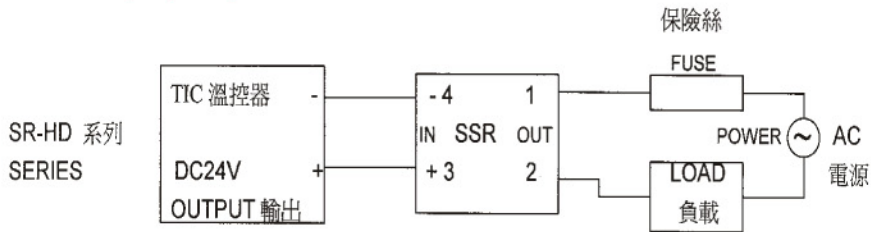

**3 PHASE WIRING EXAMPLE 三相負載控制接線如下：FOR(適用HD系列，HA系列)**

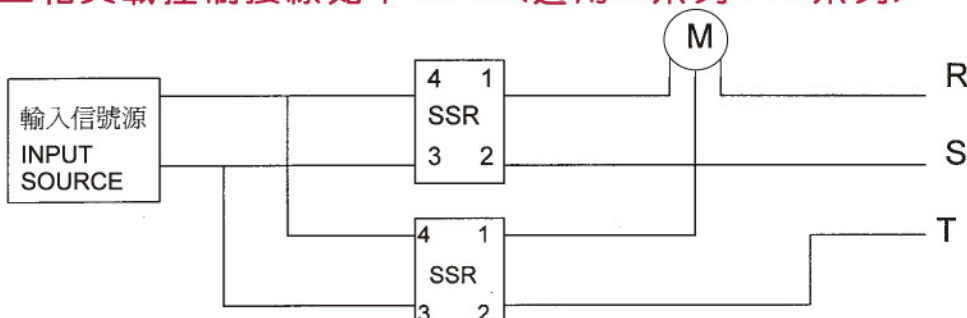

※負載測試：負載未接或電流太小(1A以下)無法正常導通，測試時請接1A以上之負載。